

# **marantz®**

**Model ZC4001 User Guide**

---

Audio Client

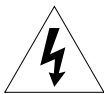
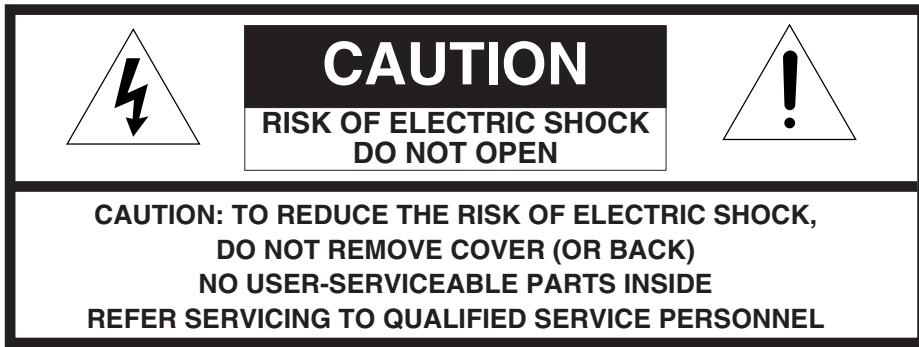

The lightning flash with arrowhead symbol within an equilateral triangle is intended to alert the user to the presence of uninsulated “dangerous voltage” within the product’s enclosure that may be of sufficient magnitude to constitute a risk of electric shock to persons.



The exclamation point within an equilateral triangle is intended to alert the user to the presence of important operating and maintenance (servicing) instructions in the literature accompanying the product.

## WARNING

**TO REDUCE THE RISK OF FIRE OR ELECTRIC SHOCK,  
DO NOT EXPOSE THIS APPLIANCE TO RAIN OR MOISTURE.**

**CAUTION: TO PREVENT ELECTRIC SHOCK, MATCH WIDE BLADE OF PLUG  
TO WIDE SLOT, FULLY INSERT.**

**ATTENTION: POUR ÉVITER LES CHOCS ÉLECTRIQUES, INTRODUIRE LA  
LAME LA PLUS LARGE DE LA FICHE DANS LA BORNE CORRESPONDANTE  
DE LA PRISE ET POUSSER JUSQU’AU FOND.**

### NOTE TO CATV SYSTEM INSTALLER:

This reminder is provided to call the CATV (Cable-TV) system installer’s attention to Section 820-40 of the NEC which provides guidelines for proper grounding and, in particular, specifies that the cable ground shall be connected to the grounding system of the building, as close to the point of cable entry as practical.

### NOTE:

This equipment has been tested and found to comply with the limits for a Class B digital device, pursuant to Part 15 of the FCC Rules. These limits are designed to provide reasonable protection against harmful interference in a residential installation. This equipment generates, uses and can radiate radio frequency energy and, if not installed and used in accordance with the instructions, may cause harmful interference to radio communications. However, there is no guarantee that interference will not occur in a particular installation. If this equipment does cause harmful interference to radio or television reception, which can be determined by tuning the equipment off and on, the user is encouraged to try to correct the interference by one or more of the following measures:

- Reorient or relocate the receiving antenna.
- Increase the separation between the equipment and receiver.
- Connect the equipment into an outlet on a circuit different from that to which the receiver is connected.
- Consult the dealer or an experienced radio/TV technician for help.

### NOTE:

Changes or modifications not expressly approved by the party responsible for compliance could void the user’s authority to operate the equipment.

# IMPORTANT SAFETY INSTRUCTIONS

## READ BEFORE OPERATING EQUIPMENT

This product was designed and manufactured to meet strict quality and safety standards. There are, however, some installation and operation precautions which you should be particularly aware of.

9. A product and cart combination should be moved with care. Quick stops, excessive force, and uneven surfaces may cause the product and cart combination to overturn.



1. Read Instructions – All the safety and operating instructions should be read before the product is operated.
2. Retain Instructions – The safety and operating instructions should be retained for future reference.
3. Heed Warnings – All warnings on the product and in the operating instructions should be adhered to.
4. Follow Instructions – All operating and use instructions should be followed.
5. Cleaning – Unplug this product from the wall outlet before cleaning. Do not use liquid cleaners or aerosol cleaners. Use a damp cloth for cleaning.
6. Attachments – Do not use attachments not recommended by the product manufacturer as they may cause hazards.
7. Water and Moisture – Do not use this product near water—for example, near a bath tub, wash bowl, kitchen sink, or laundry tub, in a wet basement, or near a swimming pool, and the like.
8. Accessories – Do not place this product on an unstable cart, stand, tripod, bracket, or table. The product may fall, causing serious injury to a child or adult, and serious damage to the product. Use only with a cart, stand, tripod, bracket, or table recommended by the manufacturer, or sold with the product. Any mounting of the product should follow the manufacturer’s instructions, and should use a mounting accessory recommended by the manufacturer.

10. Ventilation – Slots and openings in the cabinet are provided for ventilation and to ensure reliable operation of the product and to protect it from overheating, and these openings must not be blocked or covered. The openings should never be blocked by placing the product on a bed, sofa, rug, or other similar surface. This product should not be placed in a built-in installation such as a bookcase or rack unless proper ventilation is provided or the manufacturer’s instructions have been adhered to.
11. Power Sources – This product should be operated only from the type of power source indicated on the marking label. If you are not sure of the type of power supply to your home, consult your product dealer or local power company. For products intended to operate from battery power, or other sources, refer to the operating instructions.

12. Grounding or Polarization – This product may be equipped with a polarized alternating-current line plug (a plug having one blade wider than the other). This plug will fit into the power outlet only one way. This is a safety feature. If you are unable to insert the plug fully into the outlet, try reversing the plug. If the plug should still fail to fit, contact your electrician to replace your obsolete outlet. Do not defeat the safety purpose of the polarized plug.

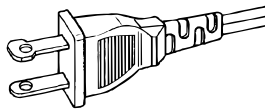

AC POLARIZED PLUG

13. Power-Cord Protection – Power-supply cords should be routed so that they are not likely to be walked on or pinched by items placed upon or against them, paying particular attention to cords at plugs, convenience receptacles, and the point where they exit from the product.
14. Protective Attachment Plug – The product is equipped with an attachment plug having overload protection. This is a safety feature. See Instruction Manual for replacement or resetting of protective device. If replacement of the plug is required, be sure the service technician has used a replacement plug specified by the manufacturer that has the same overload protection as the original plug.
15. Outdoor Antenna Grounding – If an outside antenna or cable system is connected to the product, be sure the antenna or cable system is grounded so as to provide some protection against voltage surges and built-up static charges. Article 810 of the National Electrical Code, ANSI/NFPA 70, provides information with regard to proper grounding of the mast and supporting structure, grounding of the lead-in wire to an antenna discharge unit, size of grounding conductors, location of antenna-discharge unit, connection to grounding electrodes, and requirements for the grounding electrode. See Figure 1.

16. Lightning – For added protection for this product during a lightning storm, or when it is left unattended and unused for long periods of time, unplug it from the wall outlet and disconnect the antenna or cable system. This will prevent damage to the product due to lightning and power-line surges.
17. Power Lines – An outside antenna system should not be located in the vicinity of overhead power lines or other electric light or power circuits, or where it can fall into such power lines or circuits. When installing an outside antenna system, extreme care should be taken to keep from touching such power lines or circuits as contact with them might be fatal.
18. Overloading – Do not overload wall outlets, extension cords, or integral convenience receptacles as this can result in a risk of fire or electric shock.
19. Object and Liquid Entry – Never push objects of any kind into this product through openings as they may touch dangerous voltage points or short-out parts that could result in a fire or electric shock. Never spill liquid of any kind on the product.
20. Servicing – Do not attempt to service this product yourself as opening or removing covers may expose you to dangerous voltage or other hazards. Refer all servicing to qualified service personnel.
21. Damage Requiring Service – Unplug this product from the wall outlet and refer servicing to qualified service personnel under the following conditions:
- When the power-supply cord or plug is damaged.
  - If liquid has been spilled, or objects have fallen into the product.
  - If the product has been exposed to rain or water.

- If the product does not operate normally following the operating instructions. Adjust only those controls that are covered by the operating instructions as an improper adjustment of other controls may result in damage and will often require extensive work by a qualified technician to restore the product to its normal operation.
- If the product has been dropped or damaged in any way, and
- When the product exhibits a distinct change in performance – this indicates a need for service.

22. Replacement Parts – When replacement parts are required, be sure the service technician has used replacement parts specified by the manufacturer or have the same characteristics as the original part. Unauthorized substitutions may result in fire, electric shock, or other hazards.
23. Safety Check – Upon completion of any service or repairs to this product, ask the service technician to perform safety checks to determine that the product is in proper operating condition.
24. Wall or Ceiling Mounting – The product should be mounted to a wall or ceiling only as recommended by the manufacturer.
25. Heat – The product should be situated away from heat sources such as radiators, heat registers, stoves, or other products (including amplifiers) that produce heat.

**FIGURE 1**  
**EXAMPLE OF ANTENNA GROUNDING AS PER**  
**NATIONAL ELECTRICAL CODE, ANSI/NFPA 70**

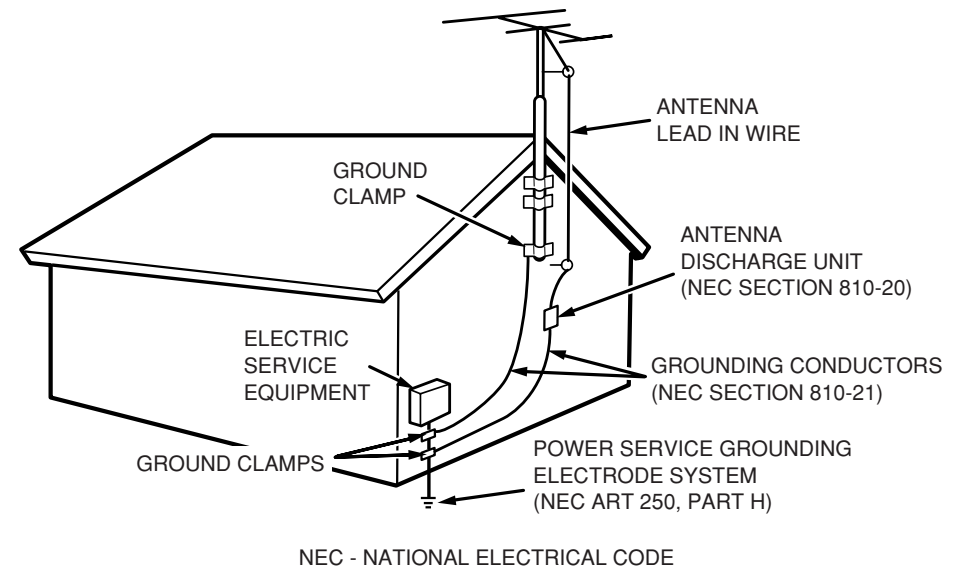

# TABLE OF CONTENTS

<b>INTRODUCTION</b> .....	<b>1</b>	<b>SETUP</b> .....	<b>6</b>
<b>PRECAUTIONS</b> .....	<b>1</b>	PLC SETTING .....	6
<b>DESCRIPTION</b> .....	<b>1</b>	SLEEP TIMER SETTING .....	7
<b>FEATURES</b> .....	<b>2</b>	BASS BOOST SETTING .....	7
<b>FRONT PANEL</b> .....	<b>3</b>	SOUND EFFECT SETTING .....	7
FL DISPLAY AND INDICATOR .....	3	DISPLAY DIMMER SETTING .....	7
<b>TOP PANEL</b> .....	<b>3</b>	CLOCK SETTING .....	8
<b>REAR PANEL</b> .....	<b>4</b>	STANDBY MODE SETTING .....	8
<b>REMOTE CONTROL OPERATION</b> .....	<b>4</b>	<b>BASIC OPERATION</b> .....	<b>9</b>
<b>CONNECTIONS</b> .....	<b>5</b>	<b>TROUBLESHOOTING</b> .....	<b>10</b>
		<b>TECHNICAL SPECIFICATIONS</b> .....	<b>10</b>
		<b>DIMENSIONS</b> .....	<b>10</b>

# INTRODUCTION

Thank you for purchasing the Marantz ZC4001 Audio Client. This remarkable component has been engineered to provide you with many years of home theater enjoyment. Please take a few minutes to read this manual thoroughly before you connect and operate the ZC4001. As there are a number of connection and configuration options, you are encouraged to discuss your own particular home theater setup with your Marantz A/V specialist dealer.

# PRECAUTIONS

## CAUTIONS ON INSTALLATION

For heat dispersal, leave at least 20 cm/8 inch of space between the top, back and sides of this unit and the wall or other components.

- Do not obstruct the ventilation holes.

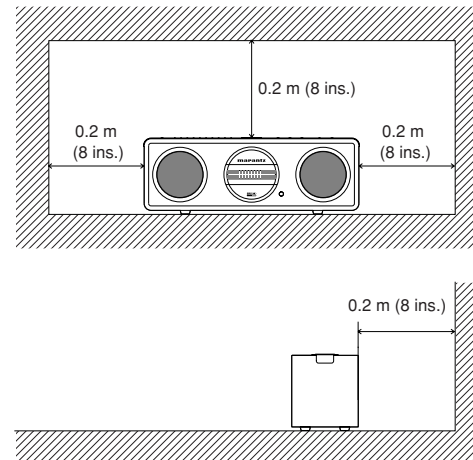

# DESCRIPTION



SRS WOW Audio Effect creates a panoramic stereo audio image by producing deep and rich bass tones and clear treble tones, enabling you to enjoy powerful sound.

WOW, SRS and (●) symbol are trademarks of SRS Labs, Inc. WOW technology is incorporated under license from SRS Labs, Inc.

# FEATURES

By simply plugging the power cables of the ZC4001 and ZR6001 into ordinary home electrical outlets, the ZR6001 sends audio sources over your home electrical line for playback by the ZC4001.

## PLC (POWER LINE COMMUNICATION)

The ZR6001\* converts analog audio signals into noncompressed linear PCM digital signals, modulates them into high frequency signals, and sends them over power lines.

The ZC4001 demodulates the sent signals and converts them back to analog signals.

\* If the condition of the power line degenerates because of the effects of noise from other devices or for other reasons, the ZR6001 uses an audio format of different sampling rate and data bit length.

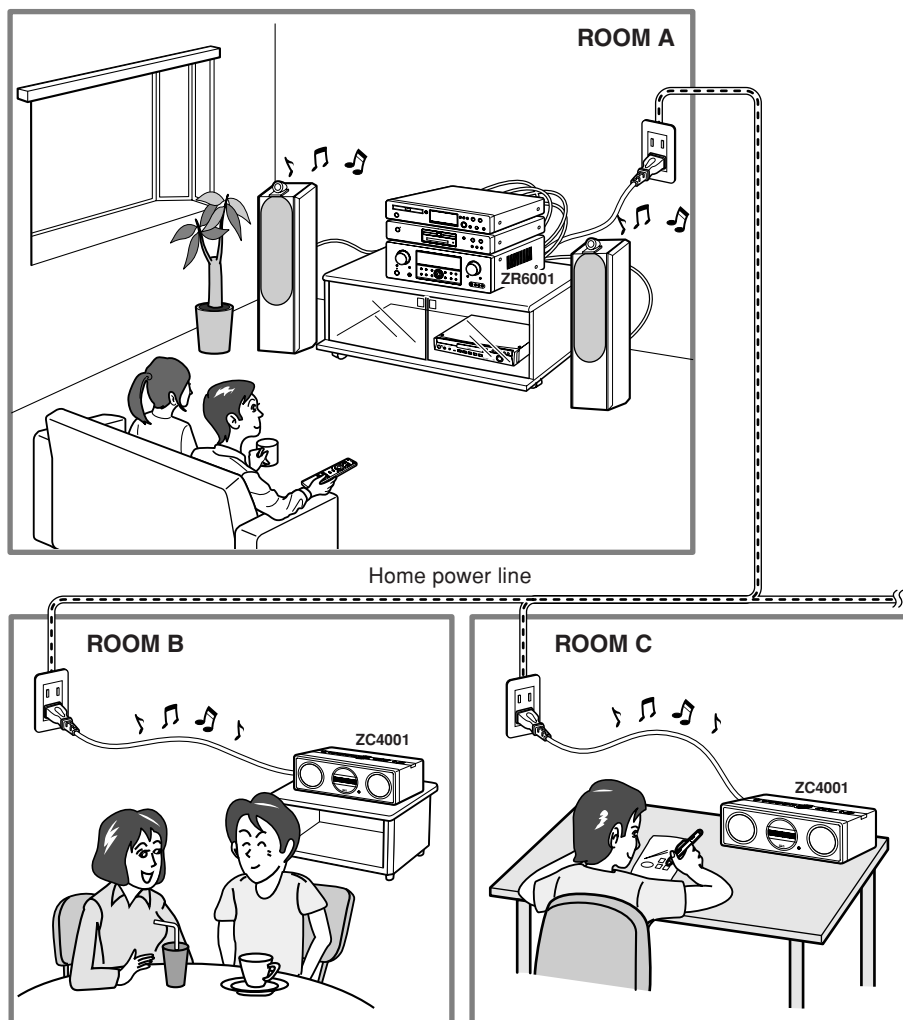

## FRONT PANEL

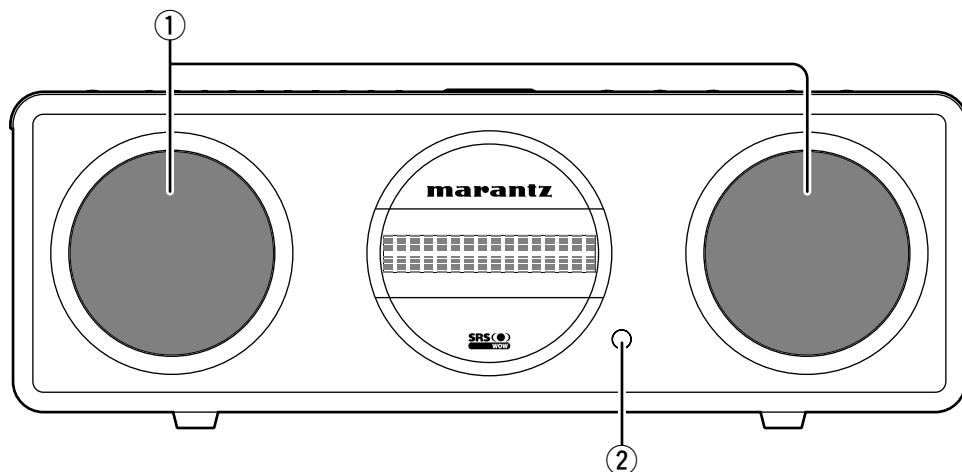

① **SPEAKERS**

② **INFRARED receiver window**

This window receives infrared signals for the remote control unit.

## FL DISPLAY AND INDICATOR

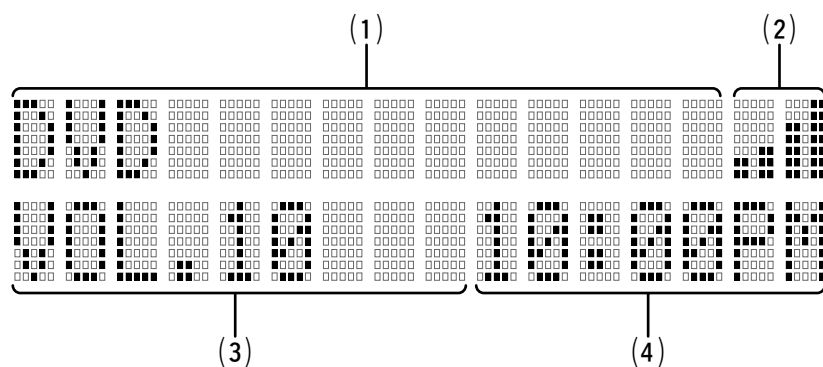

(1) **Function display area**

This area displays the input source.

(3) **Volume/ Text display area**

This area displays the volume and other text.

(2) **PLC Status display area**

This area displays the PLC reception strength.

(4) **Clock display area**

This area displays the time.

## TOP PANEL

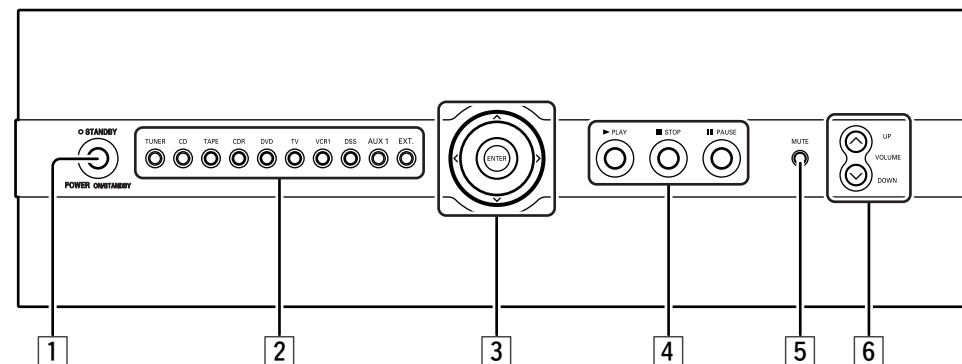

① **POWER button and STANDBY indicator**

When this button pressed once, the unit turns ON and the display illuminates. When pressed again, the unit turns OFF and the STANDBY indicator will be illuminated.

④ **CONTROL buttons**

These buttons are used when operating the PLAY, STOP, PAUSE, and other commands of a source.

② **SOURCE buttons**

These buttons are used to switch the source of ZR6001.

⑤ **MUTE button**

Press this button to mute the output to the speakers. Press it again to return the previous volume level.

\* When the EXT. button is pressed, the source switches to the EXT. INPUT jack on the rear panel.

③ **Cursor (<, >, ^, v)/ENTER buttons**

These buttons are used to operate the menu system and source units.

⑥ **VOLUME UP(^)/DOWN(v) buttons**

This button is volume control of the ZC4001.

## REAR PANEL

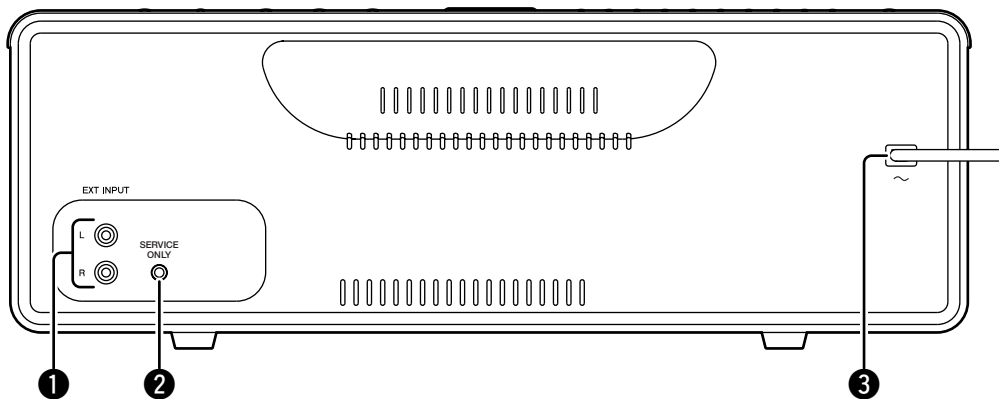

### ① EXT INPUT

This is the analog audio input. The audio inputs require RCA-type connectors.

### ② SERVICE ONLY

This is a servicing port. Do not connect anything to it.

### ③ AC Power cable

Connect the power outlet on the wall.

## REMOTE CONTROL OPERATION

The ZC4001 does not come with a remote controller.

However, it does have an infrared sensor that functions as a remote control signal receptor, and therefore it can be operated with the system remote controller (RC5500SR, etc.) of other Marantz products.

### Remote-controllable range

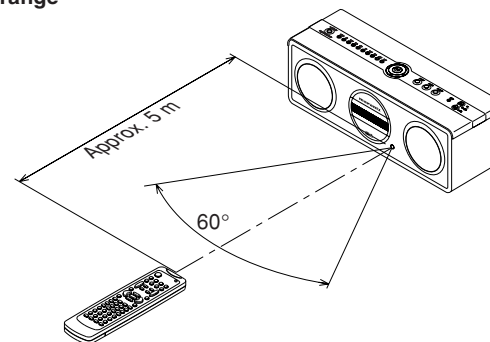

The distance between the transmitter of the remote control unit and the infrared sensor of the ZC4001 should be less than about 16.4 ft (5meters).

If the transmitter is pointed away from the infrared sensor or if there is an obstacle between them, remote control may not be possible.

# CONNECTIONS

## CONNECTING AUDIO COMPONENTS

There is one Audio EXT INPUT jack on the rear panel. You can use this jack to input analog audio signal from CD, TAPE DECK, or other analog source component.

## CONNECTING AC POWER CABLE

Connect the AC power cable of the ZC4001 to a wall electrical outlet. Also connect the AC power cable of the ZR6001 to a wall electrical outlet.

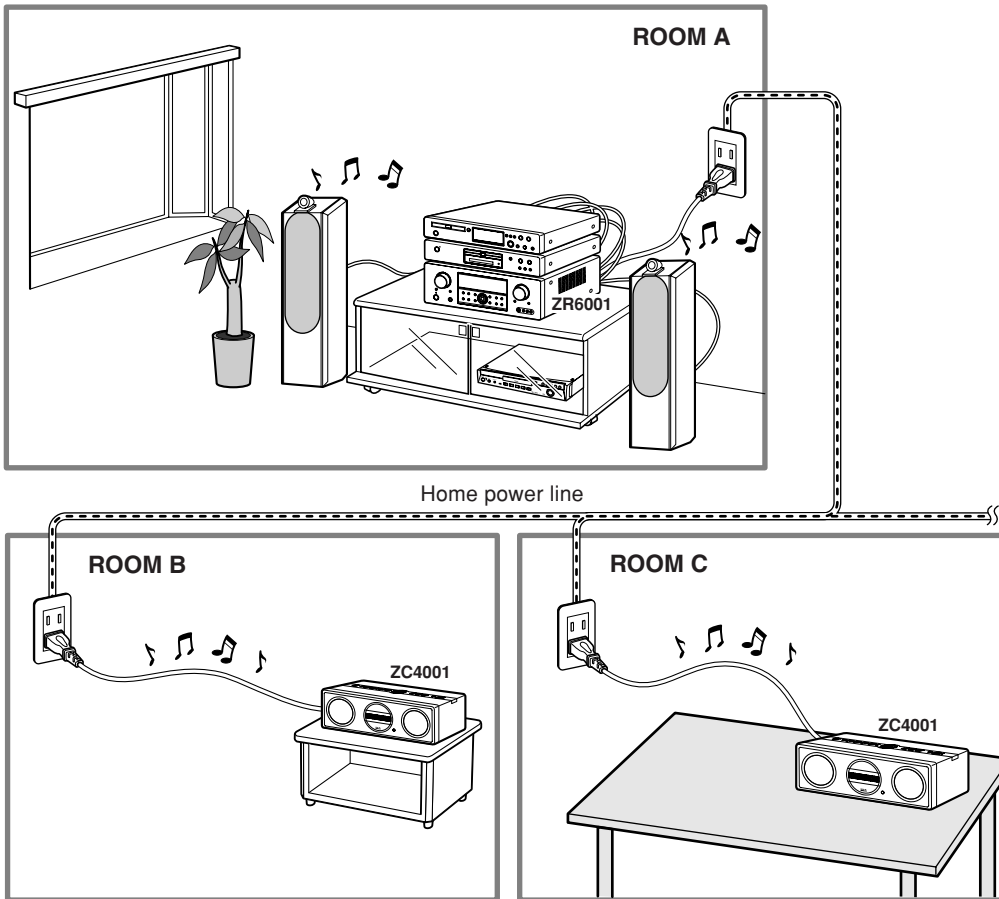

Up to four ZC4001 units may be connected to the same system at one time.

## Notes:

- The ZC4001 and ZR6001 send audio data over power lines. Therefore, if the condition of the power line degenerates seriously because of the effects of noise from other devices or for other reasons, audio data may not be received or may skip.
- If the distance of the power line between the ZC4001 and ZR6001 is very long, audio data may not be received or may skip.
- At the time of purchase, all ZC4001 and ZR6001 are set to the same Group ID. If used with this same Group ID, you risk having your music listened into by others. Therefore, set the Group ID as explained herein.
- If the following trouble is experienced, block PLC signals from other sources using a commercially available power filter, etc.

When a ZC4001 and ZR6001 are connected over PLC, another ZR6001 cannot be added to the same power line and connected over PLC. In this case, PLC signals are not sent.

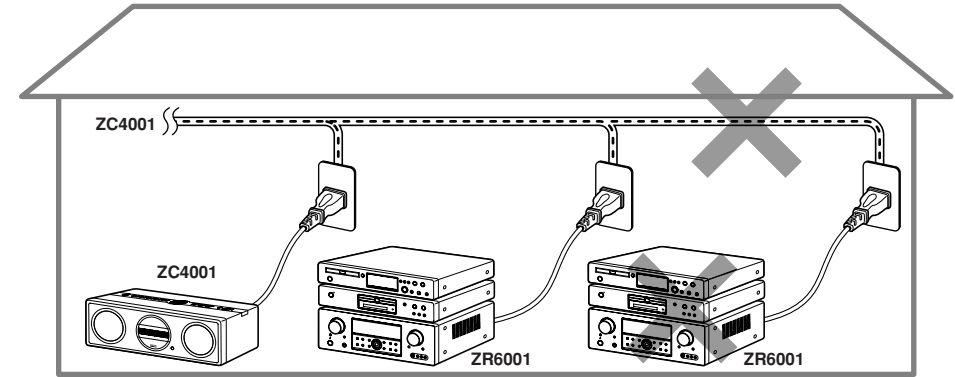

If a ZR6001 and ZC4001 are connected over PLC in a nearby apartment unit for example, and there is only a short distance between your apartment and your neighbor's, the PLC signals from your neighbor's apartment can travel over power lines to your place, mix with your system, and prevent audio output.

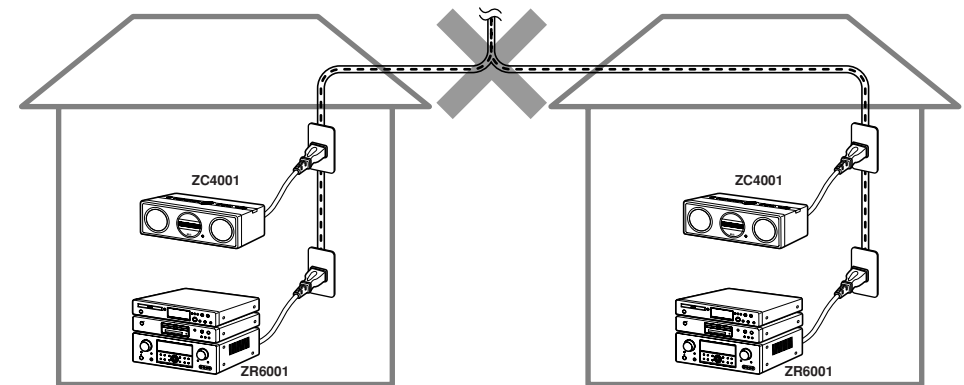



# SETUP

## PLC SETTING

### RECALIBRATION

If audio is lost when the ZC4001 and ZR6001 are connected over a PLC connection, recalibrate the signal to the best carrier frequency. The ZR6001 is set first.

#### <ZR6001>

Using the OSD menu system, set "MULTI PLC SERVER" to "ON".

#### ZR6001 ON SCREEN DISPLAY MENU SYSTEM

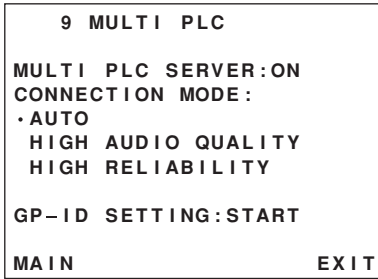

1. Select "9. MULTI PLC" in the SETUP MAIN MENU with the ▲ or ▼ cursor buttons, and press the ENTER button.
2. Select "MULTI PLC SERVER" with the ▲ or ▼ cursor buttons. And select "ON" with the ◀ or ▶ cursor buttons.

For details, see page 24 in the ZR6001 User's Guide.

#### <ZC4001>

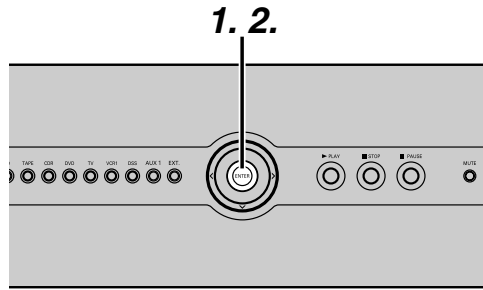

1. Press and hold the ENTER button for 5 sec. or more.

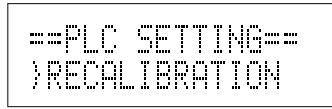

2. Press the ENTER button.



3. The below message appears when recalibration is complete.

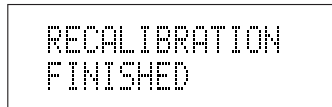

### SET GROUP ID

To set a Group ID, connect the AC power cables of the ZC4001 and ZR6001 to wall power outlets as close to each other as possible. Set the Group ID simultaneously for the ZC4001 and ZR6001.

#### <ZR6001>

Using the OSD menu system, set "GP-ID SETTING" to "START".

#### ZR6001 ON SCREEN DISPLAY MENU SYSTEM

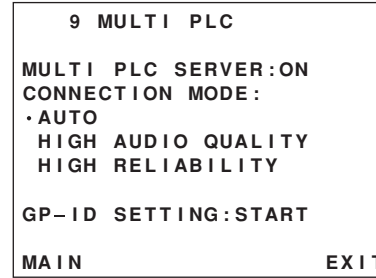

1. Select "9. MULTI PLC" in the SETUP MAIN MENU with the ▲ or ▼ cursor buttons, and press the ENTER button.
2. Select "GP-ID SETTING" with the ▲ or ▼ cursor buttons.

#### <ZC4001>

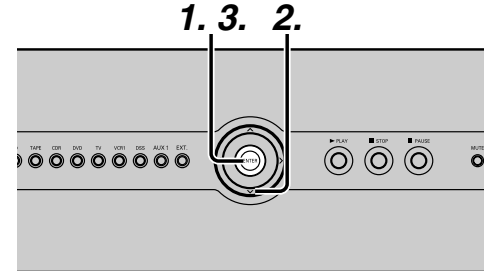

1. Press and hold the ENTER button for 5 sec. or more.

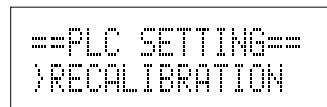

2. Press the ▼ button once.

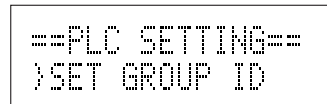

3. Simultaneously press the ENTER buttons of the ZR6001 and ZC4001.

#### <ZR6001>

GP-ID SETTING : \* \*

#### <ZC4001>



The below message appears when the Group ID has been successfully set.

#### <ZC4001>



#### <ZR6001>

GP-ID SETTING : SUCCEED

The below message appears if the units fail to set the Group ID.

#### <ZC4001>

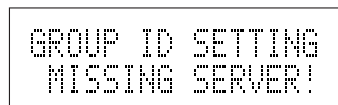

#### <ZR6001>

GP-ID SETTING : MISSING

#### Notes:

One possible reason the Group ID cannot be set is power line noise. In that case, unplug the power cable of the device that is generating noise, then plug it back in and try setting the Group ID again.

### SLEEP TIMER SETTING

When the set time elapses, the ZC4001 automatically goes on standby. The sleep timer can be set to 10, 20, 30, 40, 50, 60, 70, 80 or 90 min.

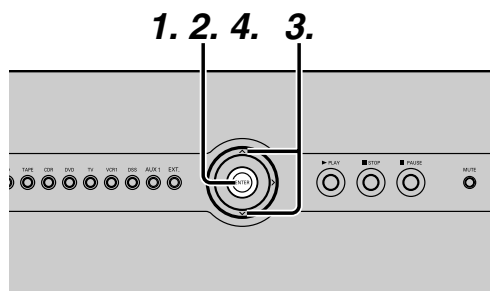

1. Press the **ENTER** button.



2. Press the **ENTER** button again.

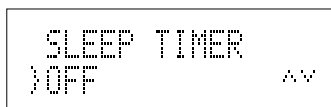

3. Select the sleep time. Each time the **▲** button is pressed, the sleep time changes in the order of OFF → 10 → 20 → 30 → 40 → 50 → 60 → 70 → 80 → 90 → OFF. Each time the **▼** button is pressed, the sleep time changes in the order of OFF → 90 → 80 → 70 → 60 → 50 → 40 → 30 → 20 → 10 → OFF.

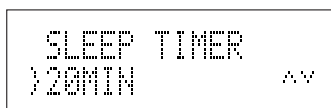

4. Press the **ENTER** button to return to the normal display.

### WAKE UP TIMER

The Wake Up Timer outputs an audio alarm at the set time. The volume level of the alarm can be user-set.

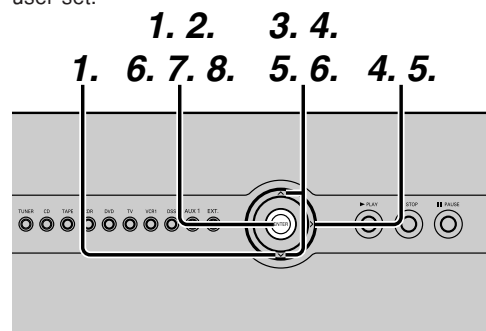

1. Press the **ENTER** button once, then press the **▼** button.

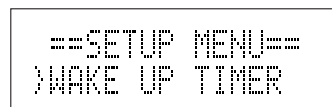

2. Press the **ENTER** button again.

3. Each time the **▲** and **▼** buttons are pressed, the Wake Up Timer switches between "ON" and "OFF".

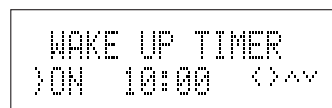

4. Press the **▶** button to get the hour setting. Press the **▲** and **▼** buttons to set the hour.

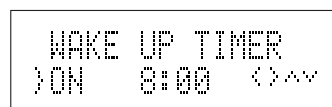

5. Press the **▶** button to get the minutes setting. Press the **▲** and **▼** buttons to set the minutes.

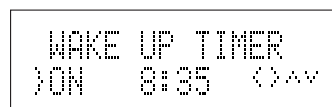

6. Press the **ENTER** button again. Press the **▲** and **▼** buttons to set the volume of the alarm.

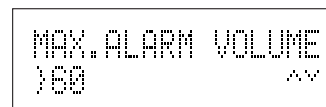

7. Press the **ENTER** button to return to the normal display. When the Wake Up Timer is turned ON, a symbol **♪** appears in front of the time display.

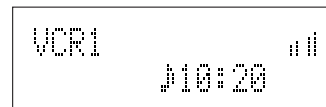

8. When the set time is reached, an audio alarm outputs. If not stopped, the alarm gradually gets louder. To stop the alarm, press the **ENTER** button. The Wake Up Timer can be set when the Standby Mode is set to "NORMAL".

### BASS BOOST SETTING

The Bass Boost feature is turned ON/OFF as follows. When ON, bass tones are accented. When OFF, normal audio is produced.

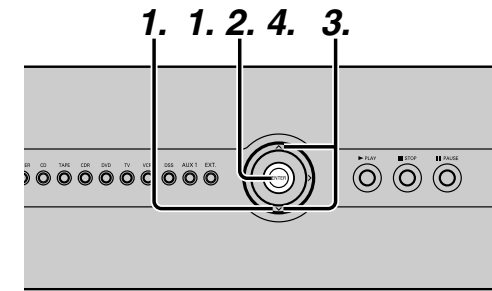

1. Press the **ENTER** button once, then press the **▼** button twice.

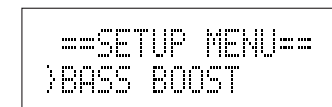

2. Press the **ENTER** button again.

3. Each time the **▲** button is pressed, the Bass Boost setting switches between ON and OFF. ON ↔ OFF

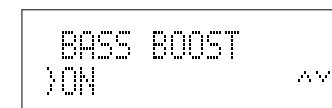

4. Press the **ENTER** button to return to the normal display.

### SOUND EFFECT SETTING

The Sound Effect mode is set as follows: Sound dynamics increase in the order of MODE1 → MODE2 → MODE3.

Setting the NIGHT MODE compresses the dynamic range.

This softens loud passages such as sudden explosions, to help prevent disturbing others late at night.

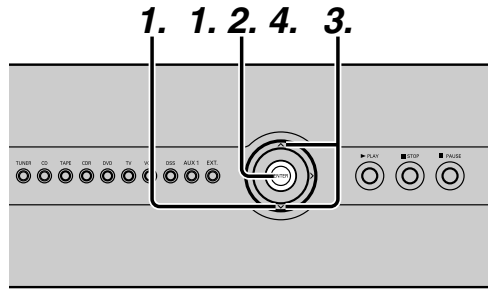

1. Press the **ENTER** button once, then press the **✓** button three times.

```
==SETUP MENU==
>SOUND EFFECT
```

2. Press the **ENTER** button again.
3. Select a Sound Effect mode. Each time the **▲** button is pressed, the Sound Effect mode changes in the order of OFF → MODE1 → MODE2 → MODE3 → NIGHT MODE → OFF. Each time the **▼** button is pressed, the Sound Effect mode changes in the order of OFF → NIGHT MODE → MODE3 → MODE2 → MODE1 → OFF. WOW is activated in all three Sound Effect modes: 1, 2 and 3.

```
SOUND EFFECT
>MODE2 (WOW) ▲▼
```

4. Press the **ENTER** button to return to the normal display.

### DISPLAY DIMMER SETTING

The brightness of the FL display can be adjusted. The display darkens in the order of OFF → LEVEL1 → LEVEL2 → LEVEL3.

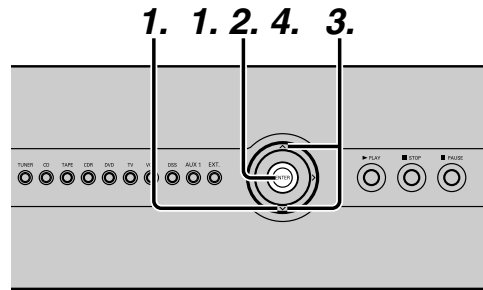

1. Press the **ENTER** button once, then press the **✓** button four times.

```
==SETUP MENU==
>DISPLAY DIMMER
```

2. Press the **ENTER** button again.
3. Select a dimmer level. Each time the **▲** button is pressed, the brightness of the FL display changes in the order of OFF → LEVEL1 → LEVEL2 → LEVEL3 → OFF. Each time the **▼** button is pressed, the brightness of the FL display changes in the order of OFF → LEVEL3 → LEVEL2 → LEVEL1 → OFF.

```
DISPLAY DIMMER
>LEVEL2 ▲▼
```

4. Press the **ENTER** button to return to the normal display.

### CLOCK SETTING

The time is set as follows.

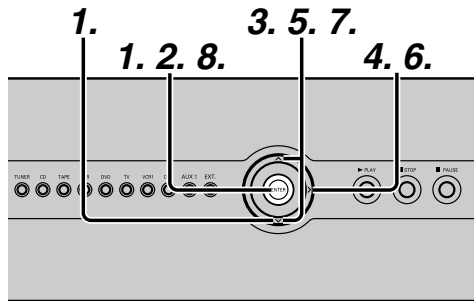

1. Press the **ENTER** button once, then press the **✓** button five times.

```
==SETUP MENU==
>CLOCK SETTING
```

2. Press the **ENTER** button again.
3. Each time the **▲** and **▼** buttons are pressed, the clock switches between the 12-hour and 24-hour display.

```
CLOCK SETTING
>12h 10:00PM <▶▲▼
```

4. Press the **▶** button to get the hour setting.
5. Press the **▲** and **▼** buttons to set the hour.

```
CLOCK SETTING
>24h 22:00 <▶▲▼
```

6. Press the **▶** button to get the minutes setting.
7. Press the **▲** and **▼** buttons to set the minutes.

```
CLOCK SETTING
>24h 22:35 <▶▲▼
```

8. Press the **ENTER** button to start the clock and return to the normal display.

### STANDBY MODE SETTING

The ZC4001 has two Standby Modes. The Standby Mode is set as follows.

**ECONOMY**: This is a low power consumption mode. The clock is not displayed.

**NORMAL**: This is the normal standby mode. The clock is displayed.

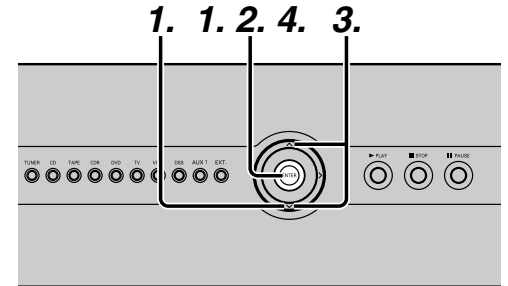

1. Press the **ENTER** button once, then press the **✓** button six times.

```
==SETUP MENU==
>STANDBY MODE
```

2. Press the **ENTER** button again.
3. Each time the **▲** and **▼** buttons are pressed, the Standby Mode switches between "ECONOMY" and "NORMAL".

```
STANDBY MODE
>ECONOMY ▲▼
```

When "ECONOMY" is set as the Standby Mode, the time is not displayed when the unit is on standby.

Also, the Wake Up Timer cannot be set in the Economy mode.

```
STANDBY MODE
>NORMAL ▲▼
```

4. Press the **ENTER** button to return to the normal display.

# BASIC OPERATION

## TURNING THE POWER ON

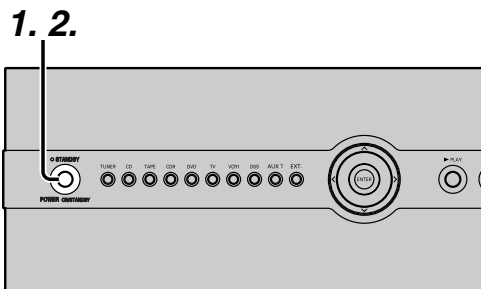

1. Press the **POWER** button to turn the power ON. When the power turns ON, the ZC4001 resumes the same status that existed when power was turned OFF the last time.
2. Press the **POWER** button again to set the ZC4001 on standby.

### Caution:

Power to the ZC4001 is always ON (standby state) while the AC power cable is connected to a wall electrical outlet. To completely shut OFF the power, unplug the AC power cable from the wall electrical outlet. However, if the AC power cable is left unplugged for an extended period of time, the clock resets and the time must be set again.

## ADJUSTING THE VOLUME

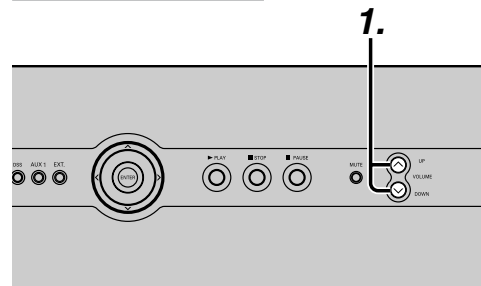

1. Press the **VOLUME**  $\wedge$  /  $\vee$  buttons to adjust the volume. Pressing the **VOLUME**  $\wedge$  button increases the volume. Pressing the **VOLUME**  $\vee$  button decreases the volume. Volume can be adjusted in the (Min.) 01 - (Max.) 79 range. Pressing and holding the **VOLUME**  $\wedge$  /  $\vee$  buttons increases or decreases the volume rapidly.

## MUTE

Pressing the **MUTE** button temporarily mutes the sound from the speakers. Pressing the **MUTE** button again cancels the mute and restores the original volume level.

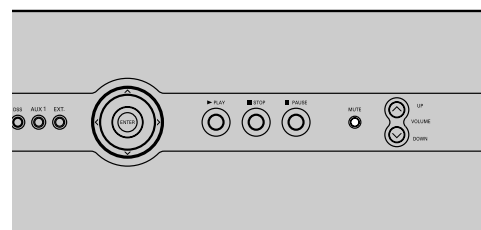

## LISTENING OVER THE PLC

Check the settings of the ZR6001. Using the OSD menu system of the ZR6001, set "MULTI PLC SERVER" to "ON". For details, see the ZR6001 User's Guide.

## ZR6001 ON SCREEN DISPLAY MENU SYSTEM

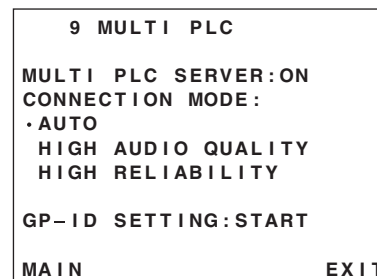

## 1. LISTENING TO THE TUNER

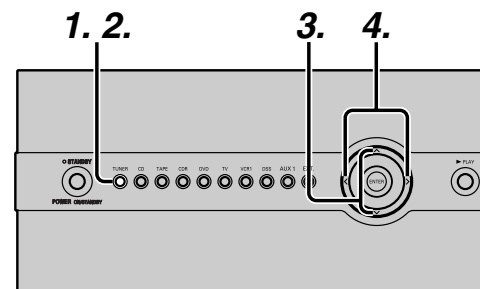

1. Press the **TUNER** button.
2. To switch between FM and AM, press the **TUNER** button again.
3. To select a station frequency, use the  $\wedge$  /  $\vee$  buttons.
4. To select a preset station, use the  $\langle$  /  $\rangle$  buttons. (With the ZR6001, this works only when stations have been preset.)

## 2. LISTENING TO SOURCES OVER THE PLC (CD, TAPE, CDR, DVD, TV, VCR1, DSS OR AUX1)

To listen to these sources, the ZR6001 must be connected to the unit and set accordingly. For details, see the ZR6001 User's Guide.

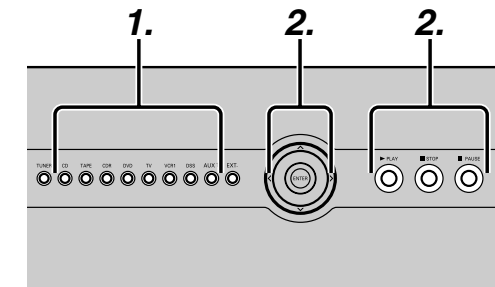

1. Press the button of the desired source.
2. Operate the source with the **PLAY**, **STOP**, **PAUSE**,  $\langle$ ,  $\rangle$ ,  $\wedge$  and  $\vee$  buttons.

## 3. LISTENING TO SOURCES CONNECTED TO EXT INPUT

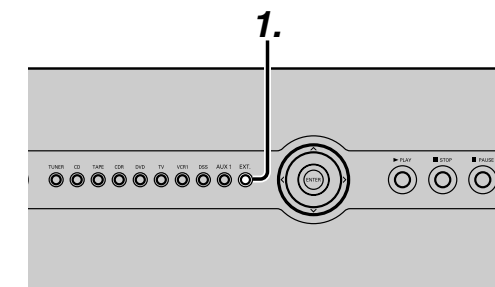

1. Press the **EXT** button.
2. Operate the unit connected to the EXT INPUT jack on the rear panel.

# TROUBLESHOOTING

In case of trouble, check the following before calling for service:

1. Are the connections made properly?
2. Are you operating the unit properly following the user's guide?
3. Are the power amplifiers and speaker working properly?

If the unit does not operate properly, check items shown in the following table. If your trouble cannot be recovered with the remedy actions listed in the following table, malfunction of the internal circuitry is suspected; immediately unplug the power cable and contact your dealer, nearest Marantz authorized dealer or the Marantz Service Center in your country.

SYMPTOM	CAUSE	REMEDY
The ZC4001 cannot be turned on.	The power plug is not connected.	Connect the power plug to the outlet.
No sound even when power is on.	Mute is on.	Cancel mute using the MUTE button.
	The input cable is not connected correctly. (EXT INPUT)	See the connection diagram and connect the cables correctly.
	The volume control is turned all the way down.	Adjust the volume.
Nothing is heard over PLC connection.	The PLC is wrongly set.	Correctly set the PLC as explained in "PLC SETTING" on page 6. You can check whether or not the ZC4001 is securely connected to the ZR6001 via the PLC status display area of the ZC4001.
	The source (Marantz product) is not correctly connected to the ZR6001.	Marantz products connect over an RC-5 bus. Correctly connect the source as explained in the ZR6001 User's Guide.
	The source (other brand product) is not correctly connected to the ZR6001.	Other brand sources are controlled by remote control signals sent from an emitter connected to the IR EMITTER OUT terminals of the ZR6001 to the IR sensor of the source unit. Operation requires you to set the brand code or use the IR code learning feature. Correctly connect the source as explained in the ZR6001 User's Guide.
	Another device is generating a high level of noise on the power line.	Turn OFF the device that is causing the noise or move it farther away from the ZC4001 and ZR6001.
	Two ZR6001 units are connected to the same system.	Using the OSD menu system, set "MULTI PLC SERVER" of one of the ZR6001 unit to "OFF". (See page 6)
Control with the remote control unit fails.	Batteries are exhausted.	Replace all the batteries with new ones.
	Function key setting for the remote control unit is wrong.	Press the AMP button on the remote control unit to confirm control of the ZR6001.
	The distance between the ZC4001 and the remote control unit is too far.	Move closer to the ZC4001.
	Something is blocking the ZC4001 and the remote control unit.	Remove the offending object.

## HOW TO RESET THE UNIT

Should the operation or display seem to be abnormal, reset the unit with the following procedure. The ZC4001 is turned on, press and hold the **MUTE** and **STOP** buttons simultaneously for 3 seconds or more.

# TECHNICAL SPECIFICATIONS

### AUDIO SECTION

Power Output ..... 10W + 10W (JEITA, 1kHz, 6 ohms)  
 .... 7W + 7W (20Hz – 20kHz, THD=0.05%, 6 ohms)  
 EXT INPUT Sensitivity/Impedance .. 200mV / 22k ohms

### PLC SECTION

Modulation Method ..... Multi carrier  
 Frequency Band ..... 2MHz – 20MHz

### GENERAL

Power Requirement ..... AC 120 V 60 Hz  
 Power Consumption ..... 0.3 A  
 Weight ..... 6.6 lbs (3.0 kg)

### ACCESSORIES

User Guide ..... 1

Specifications subject to change without prior notice.

# DIMENSIONS

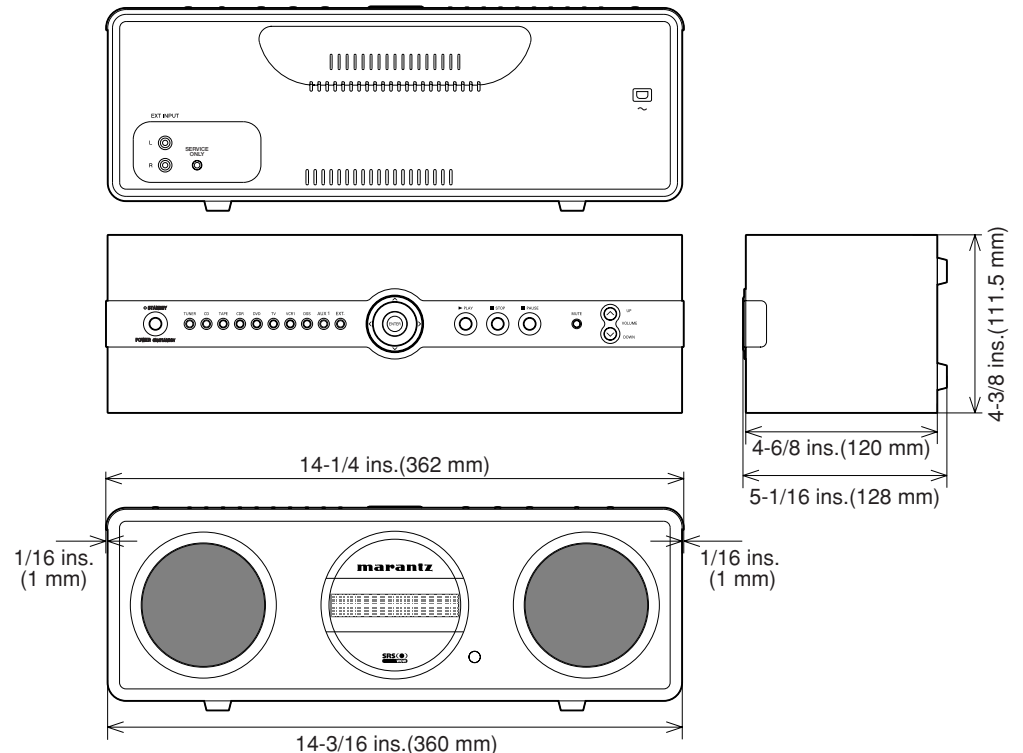

**www.marantz.com**

You can find your nearest authorized distributor or dealer on our website.

---

**U.S.A.** Marantz America, Inc. 1100 Maplewood Drive, Itasca, IL 60143, U.S.A.

**EUROPE** Marantz Europe B.V. P.O. Box 8744, 5605 LS Eindhoven, The Netherlands

---

Manufactured under license from Dolby Laboratories. "Dolby", "Pro Logic" and the double-D symbol are trademarks of Dolby Laboratories. Confidential Unpublished Works. Copyright 1992-1999 Dolby Laboratories, Inc. All rights reserved.

**marantz**<sup>®</sup> is a registered trademark.